

Firestone UltraPly™ TPO Custom Accessory Quote Form

BUILDING PRODUCTS

Customer: _____ Date: _____
 Job: _____ Delivery Date: _____
 Sales Rep: _____ License #: _____
 Ship To: _____ Bill To: _____

Color: White Tan Gray

Quote Number: _____





Important Notes:

Parts are non-adjustable, so accurate measurements are critical.
 All diameter measurements are outer diameter of the protruding pipe.
 All measurements of squares are to outer edge of protruding tube.
 All boots are made from 45-mil reinforced UltraPly TPO.
 Height measurements are to the top of the TPO membrane.
 Curb flashings higher than 12 inches must be adhered to the curb.
 Stainless steel band clamps are included with all Conical and Round boots.
 For multiple sizes use additional pages.

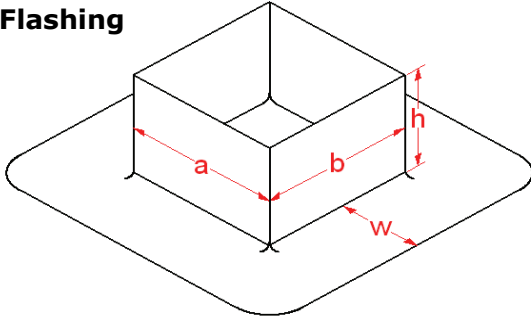
Please fax back to M.W.A
 Fax-989.496.2365

Curb Flashing



Quantity: _____
 Thickness: 45-mil 60-mil
 Dimension (a): _____ inches
 Dimension (b): _____ inches
 Height (h): _____ inches (8" minimum)
 Flange width (w): _____ inches (6" minimum)

Conical Boot

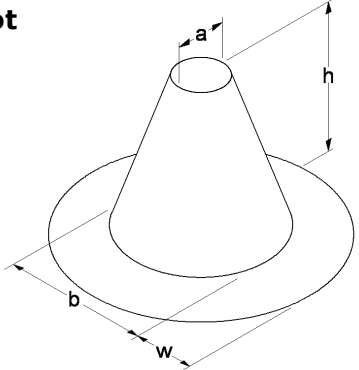

Split Closed

Quantity: _____
 Top diameter (a): _____ inches
 Bottom diameter (b): _____ inches
 Height (h): _____ inches (8" minimum)
 Flange width (w): _____ inches (6" minimum)

Pipe Boot

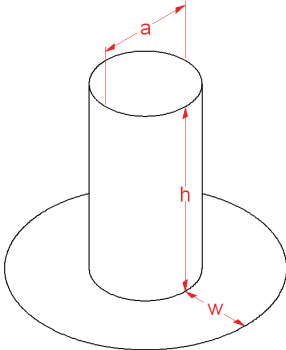

Split Closed

Quantity: _____
 Pipe diameter (a): _____ inches
 Height (h): _____ inches (8" minimum)
 Flange width (w): _____ inches (6" minimum)

Square Tube Boot

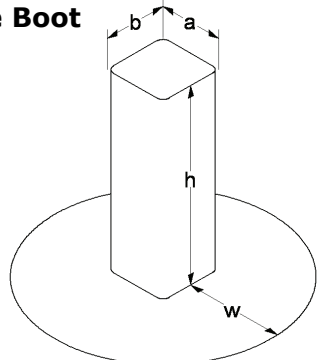

Split Closed

Quantity: _____
 Tube dimension (a): _____ inches
 Tube dimension (b): _____ inches
 Height (h): _____ inches (8" minimum)
 Flange width (w): _____ inches (6" minimum)